

CITY OF LOS ANGELES  
CALIFORNIA

BOARD OF  
BUILDING AND SAFETY  
COMMISSIONERS

VAN AMBATIELOS  
PRESIDENT

E. FELICIA BRANNON  
VICE PRESIDENT

JOSELYN GEAGA-ROSENTHAL  
GEORGE HOVAGUIMIAN  
JAVIER NUNEZ



ERIC GARCETTI  
MAYOR

DEPARTMENT OF  
BUILDING AND SAFETY  
201 NORTH FIGUEROA STREET  
LOS ANGELES, CA 90012

FRANK M. BUSH  
GENERAL MANAGER  
SUPERINTENDENT OF BUILDING

OSAMA YOUNAN, P.E.  
EXECUTIVE OFFICER

Simpson Strong-Tie  
12246 Holly Street  
Riverside, CA 92509

Attn: Tim Kaucher, P.E.  
(714) 738-2151

RESEARCH REPORT: RR 25851  
(CSI # 03 16 00)

BASED UPON ICC-ES EVALUATION  
REPORT NO. ESR-2555

REEVALUATION DUE

DATE: February 1, 2019

Issued Date: April 1, 2017

Code: 2017 LABC

**GENERAL APPROVAL** – Reevaluation and Clerical Mod - Simpson Strong-Tie MASA and MASAP Cast-in-place Foundation Anchor Straps

**DETAILS**

The above assemblies and/or products are approved when in compliance with the use, description, design, installation, conditions of use, and identification of Evaluation Report No.ESR-2555, reissued November 1, 2016, of the ICC Evaluation Service, LLC. The report, in its entirety, is attached and made part of this general approval.

The parts of Evaluation Report No.ESR-2555 marked by an asterisk are modified or deleted by the Los Angeles City Building Department from this approval.

**The approval is subject to the following conditions:**

1. The connectors must be manufactured, identified and installed in accordance with this report and the manufacturer's published installation instructions. A copy of the instructions must be available at the job site at all times during installation.
2. MASA and MASAP foundation straps shall only be used to resist loads in the manner specified in Section 4.1, with capacities in Table 1, of the attached report, ESR-2555.

RR 25851  
Page 1 of 3

Simpson Strong-Tie

RE: Simpson Strong-Tie MASA and MASAP Cast-in-place Foundation Anchor Straps

3. Calculations demonstrating that the applied loads are less than the allowable loads described in this report shall be submitted to the plan check Engineer at the time of permit application. The calculations shall be prepared by a Civil or Structural Engineer registered in the State of California. Adjustment factors, as noted in Section 4.1 of ESR-2555, shall be accounted for.
4. Minimum installation dimensions per footnote 6 of Table 1 of the attached report, ESR-2555, shall be provided.
5. Connected wood members and fasteners must comply respectively with Sections 3.2.3 and 3.2.4 of ESR-2555.
6. Connected cold form steel members and fasteners must comply respectively with Sections 3.2.2 and 3.2.4 of ESR-2555.
7. For installation, periodic special inspection is required for foundation anchor straps that are considered components within the seismic-force-resisting system in Seismic Design Categories C, D, E and F in accordance with Section 4.3 of Report No. ESR-2555.

## **DISCUSSION**

The clerical modification is to update the report to the 2017 Los Angeles City Building Code.

The report is in compliance with the 2017 Los Angeles City Building Code.

The approval is based on tests in accordance with ICC ES Acceptance Criteria for Cast-in-place Cold-formed Steel Connectors in Concrete for Light-Frame Construction (AC398), dated October 2008 (editorially revised January 2012).

This general approval will remain effective provided the Evaluation Report is maintained valid and unrevised with the issuing organization. Any revisions to the report must be submitted to this Department, with appropriate fee, for review in order to continue the approval of the revised report.

Addressee to whom this Research Report is issued is responsible for providing copies of it, complete with any attachments indicated, to architects, engineers and builders using items approved herein in design or construction which must be approved by Department of Building and Safety Engineers and Inspectors.

Simpson Strong-Tie

RE: Simpson Strong-Tie MASA and MASAP Cast-in-place Foundation Anchor Straps

This general approval of an equivalent alternate to the Code is only valid where an engineer and/or inspector of this Department has determined that all conditions of this approval have been met in the project in which it is to be used.

---

QUAN NGHIEM, Chief  
Engineering Research Section  
201 N. Figueroa St., Room 880  
Los Angeles, CA 90012  
Phone- 213-202-9816  
Fax- 213-202-9943

EB  
RR 25851  
TLB1700134  
R04/10/17  
2304.9

Attachments: ICC-ES Evaluation Report No.ESR-2555 (6 pages)

# ICC-ES Evaluation Report

**ESR-2555**

Reissued November 2016

This report is subject to renewal November 2017.

[www.icc-es.org](http://www.icc-es.org) | (800) 423-6587 | (562) 699-0543

A Subsidiary of the International Code Council®

**DIVISION: 03 00 00—CONCRETE**  
**Section: 03 16 00—Concrete Anchors**

**DIVISION: 06 00 00—WOOD, PLASTICS, AND COMPOSITES**  
**Section: 06 05 23—Wood, Plastic, and Composite Fastenings**

**REPORT HOLDER:**

**SIMPSON STRONG-TIE COMPANY INC.**  
**5956 WEST LAS POSITAS BOULEVARD**  
**PLEASANTON, CALIFORNIA 94588**  
**(800) 999-5099**  
[www.strongtie.com](http://www.strongtie.com)

**EVALUATION SUBJECT:**

**SIMPSON STRONG-TIE® CAST-IN-PLACE FOUNDATION ANCHOR STRAPS**

**1.0 EVALUATION SCOPE**

**Compliance with the following codes:**

- 2015, 2012, 2009 and 2006 *International Building Code*® (IBC)
- \* ■ 2015, 2012, 2009 ~~and 2006~~ *International Residential Code*® (IRC)

**Property evaluated:**

Structural

**2.0 USES**

The Simpson Strong-Tie® MASA and MASAP foundation anchor straps described in this report are used to connect light-frame construction foundation plates (sill plates), having a 2-inch or 3-inch nominal thickness, to concrete foundations or foundation walls. The anchor straps are structural connectors cast-in-place into normal-weight concrete, and resist uplift and sliding forces that result from the application of code-prescribed loads for light-frame construction in accordance with Sections [1604.8.1](#) and [2308.3](#) of the 2015 IBC, Sections [1604.8.1](#), [2308.3.3](#), [2308.6](#), [2308.11.3.1](#), [2308.12.8](#), and [2308.12.9](#) of the 2012 and 2009 IBC, and Sections [1604.8.1](#), [1805.6](#), [2305.3.11](#), [2308.3.3](#), [2308.6](#), [2308.11.3.1](#), [2308.12.8](#) and [2308.12.9](#) of the 2006 IBC. These foundation anchor straps may also be used under the IRC in accordance with 2015, 2012, \* 2009 ~~and 2006~~ IRC Sections [R301.1.3](#), [R403.1.6](#), and [R602.11](#).

**3.0 DESCRIPTION**

**3.1 MASA and MASAP Foundation Anchor Straps:**

The MASA and MASAP foundation anchor straps are manufactured from No. 16 gage [0.0555-inch base-metal thickness (1.4 mm)], cold-formed, galvanized sheet steel. Each anchor strap has one end that embeds into a concrete foundation. This end of the anchor strap has two standoff legs that facilitate placement onto the concrete formwork in accordance with the installation instructions prior to placement of concrete. The other end of the foundation anchor strap extends above the concrete foundation or foundation wall and is field-bent over nominally 2-inch or 3-inch foundation sill plates (sole plates) and is fastened to the foundation sill plate or bottom track, or fastened to both the foundation sill plate or bottom track and an adjacent stud, as shown in [Figure 3](#) and [Figure 6](#). The MASA anchor strap is die-formed into a shape that facilitates installation at the top of concrete forms as shown in [Figure 1](#), and the MASAP anchor strap is die-formed into a shape that facilitates installation for panelized formwork as shown in [Figure 2](#).

**3.2 Materials:**

**3.2.1 Connector Steel:** The foundation anchor straps described in this report are manufactured from galvanized steel complying with [ASTM A653](#), SS designation, Grade 33, with minimum yield strength,  $F_y$ , of 33,000 psi (227 MPa), a minimum tensile strength,  $F_u$ , of 45,000 psi (310 MPa), and a tensile elongation greater than 14 percent. The foundation anchor straps have a minimum G90 zinc coating specification in accordance with ASTM A653. The anchors are also available with a G185 zinc coating, denoted by model numbers ending with Z. Model numbers in this report do not list the Z ending, but the information shown applies. The lumber treater's recommendations or recommendations of Simpson Strong-Tie Company, Inc., on minimum corrosion resistance and connection capacities of connectors used with the specific proprietary preservative-treated or fire-retardant treated lumber, must be followed.

**3.2.2 Cold-formed Steel (CFS) Structural Members:**

The allowable loads for connectors described in this evaluation report are based on CFS members (see applicable portions of [Table 1](#) and [Figure 6](#)) evaluated using No. 18 gage [43-mil (1.09 mm) base-metal thickness] steel complying with ASTM A653, Grade 33,  $F_y = 33$  ksi,  $F_u = 45$  ksi. Connectors used with CFS members must not be installed over sheathing.

**3.2.3 Wood:** Wood members with which the connectors are used must be either sawn dimension lumber or, when

approved by the code official, engineered lumber complying with an ICC-ES evaluation report. The maximum moisture content is 19 percent for sawn dimension lumber and 16 percent for engineered lumber except as noted in Section 4.1 of this report, and the minimum specified specific gravity is 0.50, such as for Douglas fir–larch. Nominally 2-inch- and 3-inch-thick wood foundation plates (sole plates) must comply with Sections [2304.3.1](#) and [2304.12.1.2](#) of the 2015 IBC, [2304.3.1](#) and [2304.11.2.2](#) of the 2012 and 2009 IBC, and [2304.3.1](#), [2304.11.2.2](#) and 2305.3.11 of the 2006 IBC; or Sections [R404.3](#) and [R602.3.4](#) of the IRC. Installations over sheathing shown in [Figure 5](#) shall be for maximum 1/2-inch nominal sheathing thickness. The sheathing must comply with Section 2304.12.1.2 of the 2015 IBC or Section 2304.11.2.2 of the 2012, 2009, and 2006 IBC.

**3.2.4 Fasteners:** Nails for wood installations must comply with [ASTM F1667](#), as referenced in Section [2303.6](#) of the IBC. The following table provides the minimum dimensions and bending yield strength ( $F_{yb}$ ) for the fastener used with foundation anchor straps described in this report. Self-tapping screw fasteners for steel-to-steel connections must comply with [ASTM C1513](#) and must extend through the steel connection a minimum of three exposed threads in accordance with American Iron and Steel Institute (AISI) [S200](#) General Provisions (NAS General for the 2006 IBC). Additionally, the screws must have allowable shear strength in accordance with Section E4.2 of [AISI S100-12](#), Section E4.3.2 of [AISI S100-07](#) (2012 and 2009 IBC) or NAS-01 (2006 IBC). See Table A below for further fastener information:

TABLE A

NAIL TYPE	SHANK DIAMETER (in.)	LENGTH (in.)	$F_{yb}$ (psi)
10d×1 1/2 common	0.148	1 1/2	90,000
#10 Screw	0.190 (nominal diameter)	3/4	See Section 3.2.4 above

For SI: 1 in. = 25.4 mm, 1 psi = 6.89 kPa.

Fasteners used in contact with preservative-treated or fire-retardant-treated lumber must comply with Section [2304.10.5](#) of the 2015 IBC, or Section [2304.9.5](#) of the 2012, 2009, and 2006 IBC; or Section [R317.3](#) of the 2015, 2012, and 2009 IRC, or ~~Section [R319.3](#) of the 2006~~, as applicable.

The lumber treater's recommendations or recommendations of Simpson Strong-Tie Company, Inc., on minimum corrosion resistance and connection capacities of fasteners used with the specific proprietary preservative-treated or fire-retardant treated lumber, must be followed.

**3.2.5 Concrete:** Concrete must be normal-weight concrete complying with the provisions of IBC [Chapter 19](#) or IRC Section [R402.2](#), as applicable, and must have a minimum specified concrete compressive strength,  $f'_c$ , of 2,500 psi (17.2 MPa) at 28 days, unless required otherwise by Section [1904](#) of the 2015 IBC, Section [1904.2](#) of the 2012 IBC, Section [1904.3](#) of the 2009 IBC, or Section [1904.2.2](#) of the 2006 IBC, or Section [R402.2](#) of the IRC, as applicable.

**4.0 DESIGN AND INSTALLATION**

**4.1 Design Strength:**

The allowable loads shown in the product tables of this report are based on Allowable Stress Design (ASD) and include the load duration factor,  $C_D$ , corresponding with the

applicable loads in accordance with the *National Design Specification*® (NDS) for Wood Construction, where applicable. The allowable loads are shown for different conditions, including installation configuration (2x- and 3x-wood members, CFS, standard, one leg up, two legs up, etc.), load direction (Uplift, F1, F2), load type (seismic design category or wind) and whether the concrete is cracked or uncracked. The allowable load values based on uncracked concrete are for use where analysis indicates no concrete cracking ( $f_t < f_r$ ) at service (unfactored) load levels. Footnote 7 of [Table 1](#) describes a procedure for converting the tabulated allowable stress (ASD) loads to strength design (LRFD) load values.

Tabulated allowable loads apply to foundation anchor straps connected to wood used under dry conditions and where sustained temperatures are 100°F (37.8°C) or less. When foundation anchor straps are nailed to wood that will experience sustained exposure to temperatures exceeding 100°F (37.8°C), the allowable loads based on wood connection strength shown in [Table 1](#) must be adjusted by the temperature factor,  $C_t$ , specified in the NDS. When foundation anchor straps are nailed to sawn lumber having a moisture content greater than 19 percent (16 percent for engineered wood products), or where wet service is expected, the allowable loads must be adjusted by the wet service factor,  $C_M$ , specified in the NDS.

IBC Section [1613.1](#) contains an exception that permits detached one- and two-family dwellings assigned to Seismic Design Category (SDC) A, B, or C to be exempt from the seismic design provisions of IBC Section [1613](#). When this is the case, as determined by the code official, the allowable wind (or SDC A and B) loads assigned to the anchor straps in [Table 1](#) may be used.

**4.2 Installation:**

The foundation anchor straps must be installed in accordance with this evaluation report and the manufacturer's published installation instructions. In the event of a conflict between this report and the manufacturer's published installation instructions, the most restrictive requirements govern. For buildings regulated under the IRC and conventional light-frame construction regulated under IBC Section [2308](#), the MASA and MASAP foundation anchor straps may be used to attach foundation plates (sole/sill plates) to concrete foundations or foundation walls, provided a satisfactory design is submitted to the code official showing that the specified spacing of the anchor straps provides equivalent anchorage as described in IRC Section [R403.1.6](#) or Section [R602.11.1](#), as applicable, or Section [2308.3](#) of the 2015 IBC or Sections [2308.6](#), [2308.12.8](#) and [2303.12.9](#) of the 2012, 2009, and 2006 IBC.

**4.3 Special Inspection:**

Special inspection must be conducted where required in accordance with Section [1705.3](#) of the 2015 and 2012 IBC and Section [1704.4](#) of the 2009 and 2006. Special inspection requirements need not apply to structures, or portions thereof, that qualify for exception under IBC Section [1705.3](#) for the 2015 and 2012 IBC or Sections [1704.1](#) or [1704.4](#) of the 2009 and 2006 IBC, as determined by the code official. A statement of special inspection must be prepared in accordance with Section [1705.3](#) of the 2015 and 2012 IBC and Section [1705](#) of the 2009 and 2006 IBC.

Periodic special inspection must be conducted when the MASA series foundation anchor straps are components within the main wind-force-resisting system of structures constructed in areas listed in Section [1705.11](#) of the 2015 IBC, Section [1705.10](#) of the 2012 IBC, Section [1706.1](#) of

the 2009 IBC, or Section [1705.4](#) of the 2006 IBC. Special inspection requirements do not apply to structures, or portions thereof, that qualify for exception under Sections [1704.2](#), [1705.3](#), [1705.11.1](#) or [1705.11.2](#) of the 2015 IBC, Sections [1704.2](#), [1705.3](#), [1705.11.2](#) or [1705.11.3](#) of the 2012 IBC, Sections [1704.1](#), [1704.4](#), [1706.2](#) or [1706.3](#) of the 2009 IBC, and Sections [1704.1](#) and [1704.4](#) of the 2006 IBC.

Periodic special inspection must be conducted in accordance with the applicable subsection of Section [1705.12](#) of the 2015 IBC, Section [1705.11](#) of the 2012 IBC, and Section [1707](#) of the 2009 and 2006 IBC when the MASA series foundation anchor straps are components within the seismic-force-resisting system of structures assigned to Seismic Design Category C, D, E or F. Special inspection requirements do not apply to structures, or portions thereof, that qualify for exception under Sections [1704.2](#) and [1705.12](#) of the 2015 IBC, Sections [1704.2](#) and [1705.11](#) of the 2012 IBC, Sections [1704.1](#), [1704.4](#), [1705.3](#), or [1707.3](#), and [1707.4](#) of the 2009 IBC, or Sections [1704.1](#), [1704.4](#), [1705.3](#) and [1707.3](#) of the 2006 IBC.

For installations under the IRC, special inspection is not normally required. However, for an engineered design where calculations are required to be signed by a registered design professional, periodic special inspection requirements and exemptions are as stated above, as applicable, for installations under the IRC since the design must meet IBC requirements.

## 5.0 CONDITIONS OF USE

The Simpson Strong-Tie foundation anchor straps described in this report comply with, or are suitable alternatives to what is specified in, those codes listed in Section 1.0 of this report, subject to the following conditions:

**5.1** The connectors must be manufactured, identified and installed in accordance with this report and the manufacturer's published installation instructions. A copy of the instructions must be available at the jobsite at all times during installation. In the event of a conflict between this report and the manufacturer's

published installation instructions, the more restrictive requirements shall govern.

**5.2** Calculations and details showing compliance with this report must be submitted to the code official. The calculations must be prepared by a registered design professional where required by the statutes of the jurisdiction in which the project is to be constructed.

**5.3** Adjustment factors noted in Section 4.1 and the applicable codes must be considered, where applicable.

**5.4** Connected wood members and fasteners must comply with Sections 3.2.3 and 3.2.4 respectively of this report. Connected cold-formed steel members and fasteners must comply with Sections 3.2.2 and 3.2.4 respectively of this report.

**5.5** Use of connectors with preservative- or fire-retardant-treated lumber shall be in accordance with Section 3.2.1 of this report. Use of fasteners with preservative- or fire-retardant-treated lumber shall be in accordance with Section 3.2.4 of this report.

**5.6** Special inspection must be provided in accordance with Section 4.3 of this report.

## 6.0 EVIDENCE SUBMITTED

Data in accordance with the ICC-ES Acceptance Criteria for Cast-in-place Cold-formed Steel Connectors in Concrete for Light-frame Construction (AC398), dated October 2008 (editorially revised July 2015 and January 2012).

## 7.0 IDENTIFICATION

The Simpson Strong-Tie foundation anchor straps described in this report are identified with a die-stamped label or an adhesive label indicating the name of the manufacturer (Simpson Strong-Tie), the model number, and the number of an index evaluation report ([ESR-2523](#)) that is used as an identifier for the products recognized in this report.

**TABLE 1—ALLOWABLE STRESS DESIGN (ASD) LOADS FOR MASA AND MASAP FOUNDATION ANCHOR STRAPS**

Wind and SDC A&B - Allowable Loads (lbs) <sup>1,2,5,6,7,9,10,11</sup>								
Sill Size	Fasteners <sup>3</sup>		Uncracked Concrete <sup>4,8</sup>			Cracked Concrete <sup>4,8</sup>		
	Sides	Top	Uplift	F1	F2	Uplift	F1	F2
			STANDARD INSTALLATION					
2x4, 2x6	3-10dx1.5	6-10dx1.5	920	1515	1095	785	1515	910
3x4, 3x6	5-10dx1.5	4-10dx1.5	650	1215	725	495	1215	725
ONE LEG UP INSTALLATION								
2x4, 2x6	6-10dx1.5	3-10dx1.5	785	1005	995	595	1005	965
3x4, 3x6	7-10dx1.6	2-10dx1.6	-	790	-	-	790	-
TWO LEGS UP INSTALLATION								
2x4, 2x6 3x4, 3x6	9-10dx1.5	-	810	1150	900	665	1150	660
DOUBLE 2x SILL INSTALLATION								
DBL 2x4, DBL 2x6	5-10dx1.5	2-10dx1.5	875	1075	785	660	1075	785
STANDARD INSTALLATION ON 2" CFS								
2" CFS Sill	3- #10 Screws	9- #10 Screws	675	1205	895	510	1205	655
ONE LEG UP INSTALLATION ON 2" CFS								
2" CFS Sill and Stud	6- #10 Screws	3- #10 Screws	-	1025	-	-	1025	-
SDC C-F - Allowable Loads (lbs) <sup>1,2,5,6,7,9,10,11</sup>								
Sill Size	Fasteners <sup>3</sup>		Uncracked Concrete <sup>4,8</sup>			Cracked Concrete <sup>4,8</sup>		
	Sides	Top	Uplift	F1	F2	Uplift	F1	F2
			STANDARD INSTALLATION					
2x4, 2x6	3-10dx1.5	6-10dx1.5	745	1235	1045	660	1235	765
3x4, 3x6	5-10dx1.5	4-10dx1.5	550	1020	725	415	1020	640
ONE LEG UP INSTALLATION								
2x4, 2x6	6-10dx1.5	3-10dx1.5	660	845	995	500	845	810
3x4, 3x6	7-10dx1.6	2-10dx1.6	-	665	-	-	665	-
TWO LEGS UP INSTALLATION								
2x4, 2x6 3x4, 3x6	9-10dx1.5	-	740	965	755	560	965	555
DOUBLE 2x SILL INSTALLATION								
DBL 2x4, DBL 2x6	5-10dx1.5	2-10dx1.5	735	900	785	555	900	785
STANDARD INSTALLATION ON 2" CFS								
2" CFS Sill	3- #10 Screws	9- #10 Screws	565	1010	750	425	1010	550
ONE LEG UP INSTALLATION ON 2" CFS								
2" CFS Sill and Stud	6- #10 Screws	3- #10 Screws	-	860	-	-	860	-

For **S**: 1 in. = 25.4 mm, 1 lbs. = 4.45 N, 1 psi. = 6.895 kPa, 1 plf. = 14.59 N/m.

<sup>1</sup>Refer to [Figures 3 - 6](#) for illustrations of anchor straps installed to wood plates or CFS tracks and wood plate/stud or CFS track/stud. Allowable loads are applicable to anchors fastened directly to the sill plate, stud, or both. For wood installations, the members must have a S.G. ≥ 0.50 (S.G. = Specific Gravity; refer to Table 12.3.3A of the 2015 NDS, Table 11.3.3A of the 2012 NDS, and Table 11.3.2A of the 2015 NDS).

<sup>2</sup>According to Section [2305.3.11](#) of the 2006 IBC, when the seismic design shear load (F1) in SDC D, E, or F exceeds 350 plf, a 3-inch nominal wood foundation plate must be used. When the seismic design shear load (F1) in SDC D, E, or F is greater than 350 plf but less than 600 plf (using ASD), the wood foundation plate may be a 2-inch nominal member provided the sill plate is anchored by 2 times the number of MASA or MASAP anchor straps required by design. Note: these provisions are only required per the 2006 IBC and are not required when designing to the 2015, 2012 or the 2009 IBC.

<sup>3</sup>Nails and screws must comply with Section 3.2.4 of this report.

<sup>4</sup>Load direction F1 is parallel to the foundation plate wood member, and load direction F2 is perpendicular to the foundation plate wood member. For simultaneous loads in more than one direction, the connector must be evaluated using the straight line interaction equation.

<sup>5</sup>Minimum specified concrete compressive strength,  $f_c$  must be 2,500 psi.

<sup>6</sup>For full allowable loads, the minimum anchor end distance is 4 inches, the minimum anchor spacing is 8 inches, and the minimum concrete stem wall width is 6-inches.

<sup>7</sup>Multiply tabulated seismic and wind ASD load values by 1.4 or 1.6 respectively to obtain LRFD capacities.

<sup>8</sup>The allowable load values based on uncracked concrete are for use where analysis indicates no concrete cracking at service (unfactored) load levels.

<sup>9</sup>IBC Section [1613.1](#) contains an exception that permits detached one- and two-family dwellings assigned to Seismic Design Category (SDC) A, B, or C to be exempt from the seismic design provisions of IBC Section [1613](#). When this is the case, the allowable wind loads assigned to the anchor straps should be used.

<sup>10</sup>The allowable loads for anchors fastened to wood members are based on allowable stress design (ASD) and include the load duration factor ( $C_D$ ) corresponding with wind and earthquake loading in accordance with the NDS ( $C_D = 1.6$ ). No further increase is allowed.

<sup>11</sup>Deflection at allowable load based on wood connection strength is less than or equal to  $1/8$  inch.

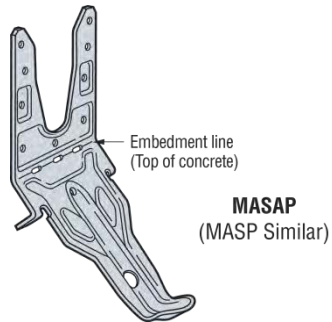
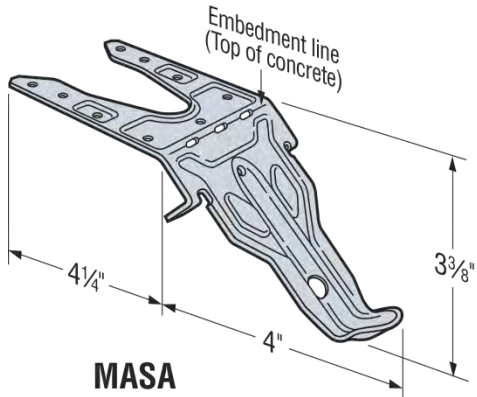
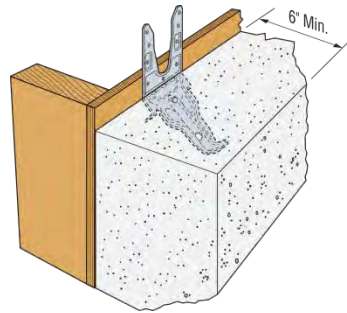
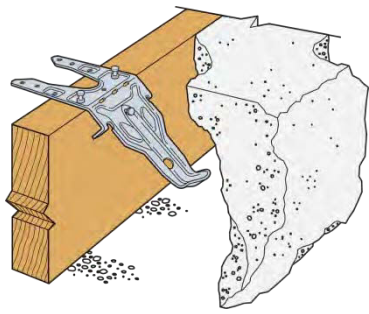

U.S. Patents 8,484,917 and D656,391S

FIGURE 1—MASA FOUNDATION ANCHOR STRAP

FIGURE 2—MASAP FOUNDATION ANCHOR STRAP

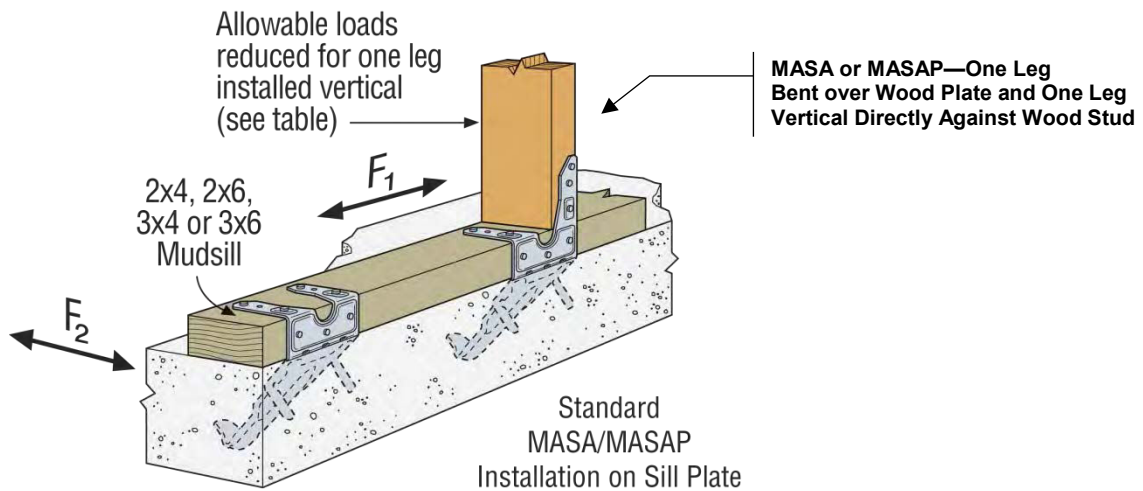

FIGURE 3—TYPICAL INSTALLATION OF MASAP FOUNDATION ANCHOR STRAPS ON SILL PLATE



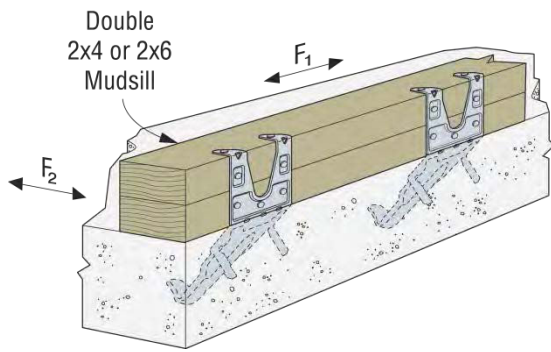

FIGURE 4—MASA/P INSTALLATION ON DOUBLE 2x MUDSILL

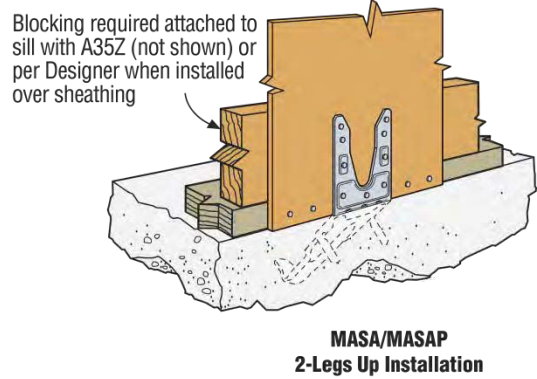

FIGURE 5—MASA/P INSTALLATION FOR TWO LEGS UP

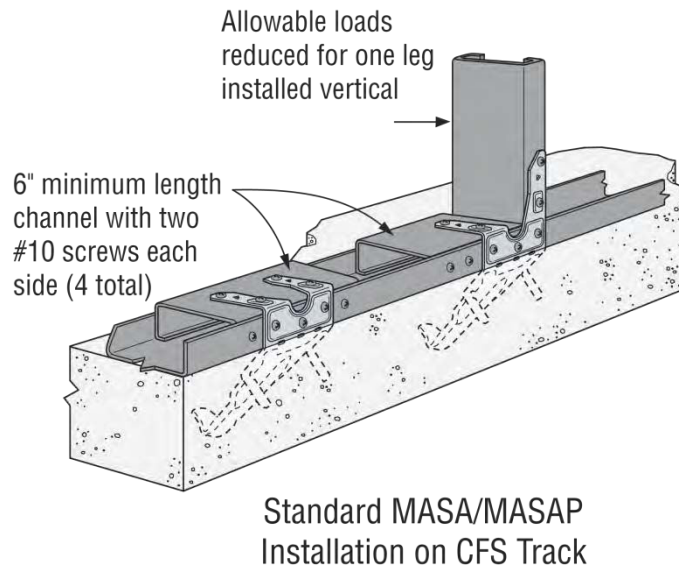

FIGURE 6—MASA/P INSTALLATION ON CFS TRACK