

## EB-TY® Premium Hidden Deck-Fastening System™



### Optimise Your Decking Investment

There's nothing like premium hardwood timber decking to add the perfect finishing touch to a beautiful outdoor living space. When investing in hardwood decking, it's vital for you to choose the right fastening method to ensure durability while letting the beauty of the material shine through.

#### Versatile

- Easy to install for professional builders and DIYers
- Ideal for premium hardwoods
- For residential and commercial applications

#### Metal Reinforced

- Provides greater holding power and increased pullover resistance
- Stainless-steel plate ensures lasting durability in demanding environments
- Prevents over-driving of the screw, helping to ensure consistent, quality installations

#### Angled Screw Attachment

- Ensures direct attachment of the board to the joist
- Keeps the board from "walking" or sliding
- Allows tighter spacing

#### Radius Sides for Easier Alignment

- The patented arc shape of the EB-TY also helps ease insertion — works with pregrooved and biscuit-cut slots
- Chamfered edges for easier board alignment and installation of successive boards

#### Covers the Joist

- Protection from direct exposure to sun and rain
- Visually more appealing after installation

#### Hardwood Plugs Included for the Starter Board

One or more of these U.S. patents may apply: 6,402,415; 8,161,702 and patents pending.

The new EB-TY Premium Hidden Deck-Fastening System is the ideal solution that blends strength with ease of installation in a fastener that won't detract from the deck's finished appearance.

Simpson Strong-Tie has redesigned the award-winning EB-TY Hidden Deck-Fastening System by integrating a Type 300 series stainless-steel reinforcing plate that adds stiffness to hold boards in place securely, yet maintains flexibility when seasonal contraction and expansion occur. Combine this innovative new design with our EB-GUIDE predrilling tool, and you have a system that not only provides hidden strength, but is also easy to install.

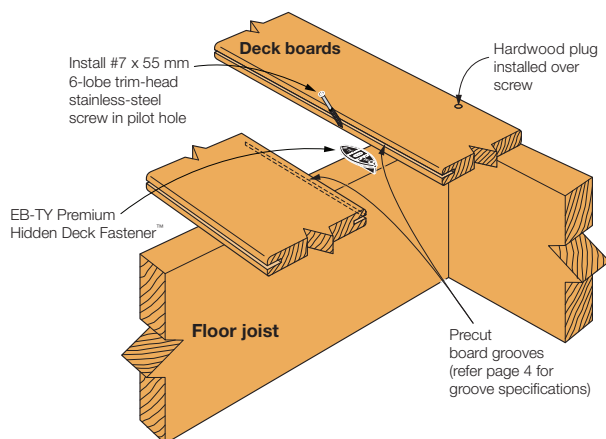
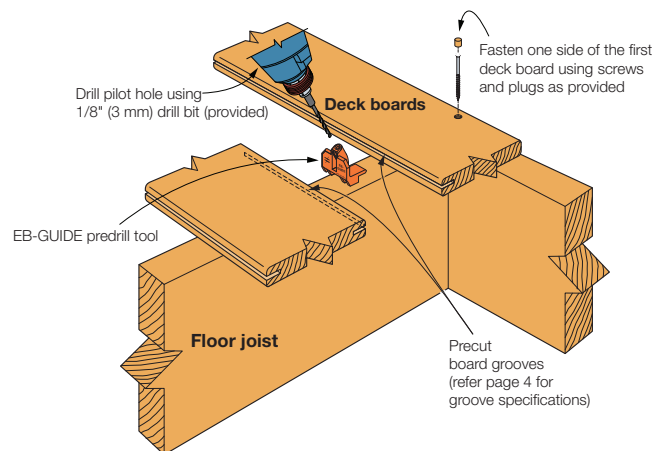

EB-TY Premium™ provides a unique method of fastening deck boards that leaves the fasteners virtually invisible. Fastening is done into the side of the board, leaving a clean, fastener-free deck surface. Apply construction adhesive to the joist for each deck board before installing the screw.

## EB-TY® Advantages

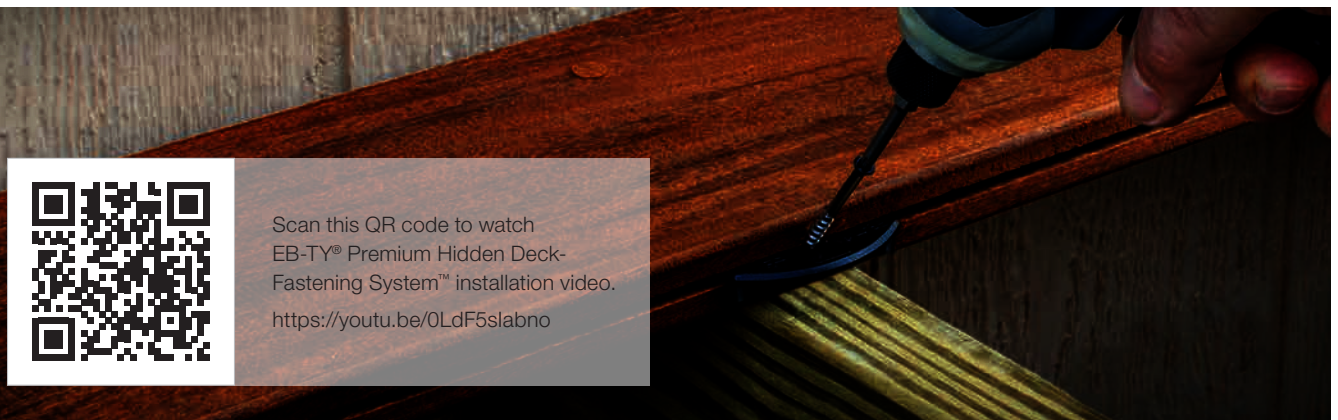

Scan this QR code to watch EB-TY® Premium Hidden Deck-Fastening System™ installation video.  
<https://youtu.be/0LdF5slabno>

The EB-TY Premium™ is a stainless-steel-reinforced polymer biscuit fastener that fits into deck boards' pre-cut slots (or into slots that the deck installer can make using a biscuit joiner saw). The biscuits are then fastened by a screw driven into the joist. Nesting each successive board against the EB-TY Premium ensures consistent spacing and uniform height.

Type 300 series stainless-steel plate reinforces EB-TY Premium, providing greater structural strength, increased holding power and pullover resistance

Underside keel provides consistent fastener positioning and gap spacing

Radius sides make for easier alignment and faster installation

Stainless-steel screws are used for a high level of corrosion resistance

Black-painted 6-lobe trim-head screw provides a concealed finish, blends in with EB-TY fastener

Includes patent-pending EB-GUIDE and impact-ready drill bit for more precise fastening to joist, ensuring the proper fastening angle

T-15 driver bit included

Screw Size	Screw Material (Trim Head)	EB-TY Premium Qty.	Screw Qty.	Merbau Style Hardwood Plug Qty.	Model No.
<b>2.4mm Board Spacing — 19–25mm decking</b>					
#7 x 55mm	Type 305	175	190	12	<b>EB332WDR175</b>
#7 x 55mm	Type 316	175	190	12	<b>EB332WD316R175</b>

1. Model numbers corresponding to kits with 175 count EB-TY Premium include 1 drill bit, T-15 driver bit and EB-GUIDE tool.
2. Kiln-dried decking has a moisture content of generally 19% or less. Air-dried decking is generally greater than 19% moisture content.

### Each Kit Contains

- EB-TY Premium biscuits
- Type 305 or 316 stainless-steel trim-head, 6-lobe screws with black-painted heads
- Hardwood plugs
- EB-GUIDE predrilling guide
- 1/8" (3 mm) quick-release drill bit
- T-15 6-lobe driver bit

### Replacement Parts

Description	Quantity	Model No.
Replacement T15 6-Lobe Driver Bit	3	<b>BIT15T-2-RC3</b>
1/8" (3mm) Quick-Release Wood Drill Bit	3	<b>WDB18QR3-R3</b>
Hardwood Plug 3/8" (10mm)	100	<b>WDPLUG-100</b>
EB-GUIDE Predrill Tool	1	<b>EB-GUIDE</b>

## EB-TY® Product Detail and Installation

### Items Needed

- Caulk gun with exterior polyurethane construction adhesive
- Exterior wood glue
- Drill
- 1/8" (3 mm) quick-release drill bit (included)
  - can be used with impact drivers
- 3/8" (10 mm) countersink if using hardwood plugs
- Mallet or dead-blow hammer
- Flush-cut saw, belt or orbital sander with 80-grit sandpaper for finishing plugs
- Router with a 3/32" (4 mm) slot cutting bit, plate or biscuit joiner (not needed for pregrooved boards)
- Board straightening tool or similar tool to move boards in place
- Measuring device



EB332WD

### ATTENTION

**BUILDER:** Please review the timber decking installation instructions provided by the timber supplier and/or manufacturer prior to installing EB-TY Premium™ fasteners. Allow moisture in the deck boards to reach equilibrium moisture content (EMC) with the surrounding environment prior to installation by allowing the decking boards to acclimate site on, well ventilated for 2-3 weeks prior to installation. Adequate airflow and proper ventilation beneath the decking are important to long-term performance of the deck.

Screws and Nails

### EB-TY Premium Installation — Overview

Apply construction adhesive to joist for each deck board prior to installing screws.

#### EB-GUIDE

#### Predrill Step

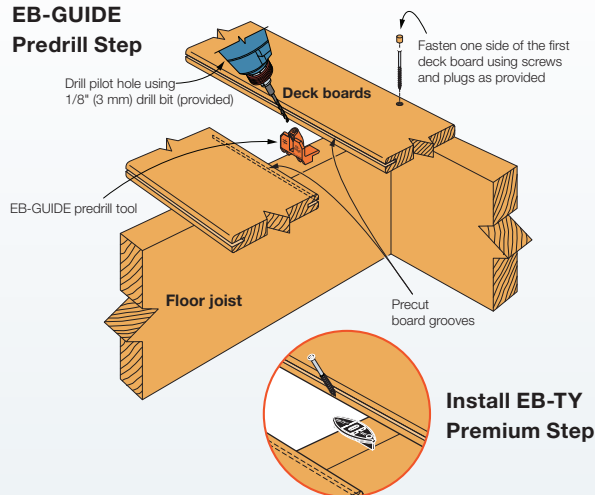

### EB-TY Premium Installation — Side View

First and last deck board screwed to header  
Other deck boards attached to joists with EB-TY® Premium Fasteners

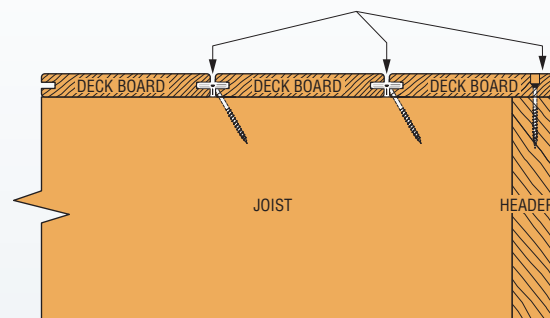

### EB-TY Pregroove Schematic

Use the schematic below to pregroove or specify your decking boards to accept EB-TY Premium fasteners.

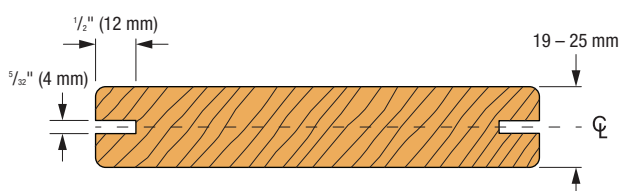

CUT GROOVE AT THE CENTRELINE OF MATERIAL THICKNESS.  
This will also allow you to flip boards if you discover a bad surface.

## EB-TY® Installation and Product Detail

### Quick Installation Guide

For detailed instructions on installing the EB-TY Premium Hidden Deck-Fastening System™ refer to page 142.



#### Step 1.

Install first board by applying construction adhesive and screwing and countersinking directly into the face of the deck board and into the joist; glue an hardwood plug in the hole.



#### Step 2.

Pre-drill using the EB-GUIDE drill guide.



#### Step 3.

Place EB-TY Premium™ in deck board groove. Fasten with trim-head screw (included) through the EB-TY and deck board and into the joist.



#### Repeat Step 2.

Apply construction adhesive to the joist. Slide adjoining deck board onto exposed EB-TY Premium radius sides. Repeat Steps 2–4, and install last board using Step 1.

### EB-TY Premium Hidden Deck Fastener™ Series EB332

- With integrated stainless-steel plate for added strength.
- For use with 19–25 mm thick deck boards, including Merbau, etc.
- For use in air-dried decking that will shrink as it acclimates to the environment.
- Provides an initial 2.4 mm spacing between deck boards.

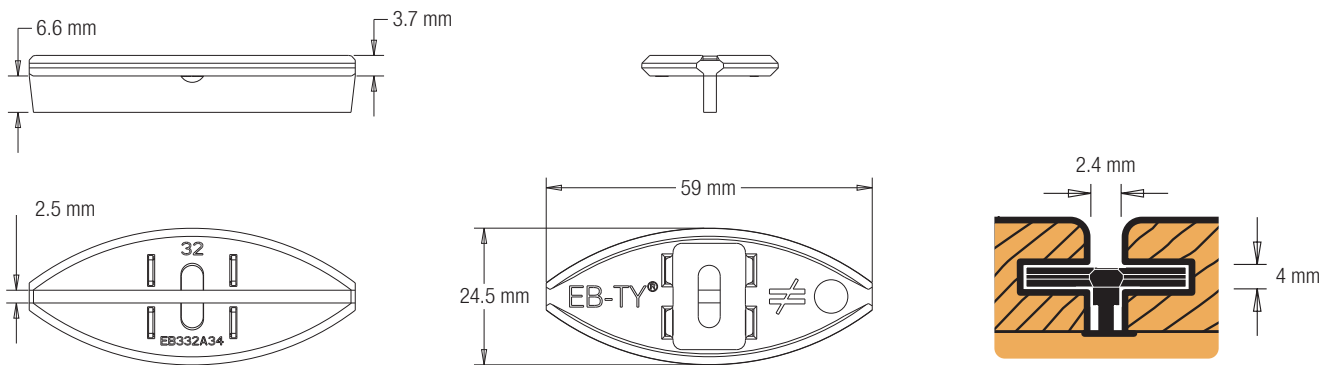

### EB-TY Premium Fastener Usage Chart

Fasteners / Square Metres Chart Dimensions	Number of EB-TY Premium Hidden Deck Fasteners™ Needed per Square Metre
90mm boards with 450mm on centre joists	33
140mm boards with 450mm on centre joists	21

## EB-TY® Detailed Installation Instructions

### Installing the First Board



**1. Apply adhesive**  
Apply a bead of exterior construction adhesive to each joist that will be under the first board — about 10 mm wide.



**2. Drill and countersink**  
Drill a 1/8" (3 mm) pilot hole through the deck board (but not into the joist) at each joist intersection of the first deck board, about 25 mm from the outer edge of the board. Drill the 3/8" (10 mm) countersink approximately 8 mm deep.



**3. Drive screws to secure first board**  
Drive a #7 stainless-steel trim-head screw (included) in each countersink, fastening the board tightly to the joist. Each EB-TY Premium™ kit includes additional screws for attaching the first board.



**4. Apply glue**  
Place a drop of wood glue into the hole and insert the hardwood plug.  
**Tip:** Try to align the wood plug grain with the board grain for a more concealed look.



**5. Install plug**  
Tap plugs tight with a mallet. Each EB-TY Premium kit includes hardwood plugs for the first board. If using a different type of wood, you can use a 3/8" (10 mm) plug cutter to make plugs from scrap board.



**6. Trim plugs and sand paper flush with board surface**  
Trim any plug material extending above the board surface using a flush-cut saw or sander — 80-grit paper is recommended. Sand all plugs until they are even with the deck board surface.



**7. Cut groove using biscuit joiner saw or router. If using pregrooved boards, skip to Step 8.**  
Using a biscuit joiner, cut a slot in the side of the deck board. Cut one slot at each deck board and joist intersection. Alternatively, you can also use a router with a 5/32" (4 mm) slotting bit instead of a biscuit joiner.

**Tip:** When cutting slots, always measure from the top surface of the board. This will help to ensure that the slots align perfectly with adjacent boards. Cut groove at the centreline of material thickness. This will also allow you to flip boards if you discover a bad surface. Refer to EB-TY Pregroove Schematic on page 140



**8. Slide in EB-GUIDE**  
Slide the EB-GUIDE into the deck board's grooved side, centring above the joist.



**9. Drill pilot hole**  
Using the drill or impact driver with the 1/8" (3 mm) drill bit (included), insert the drill bit into the EB-GUIDE hole and drill through the edge of the deck board.



**10. Insert EB-TY**  
Insert one EB-TY Premium fastener into the slot at each joist intersection, aligning EB-TY Premium over the predrilled pilot hole.



**12. Drive screw**  
Install a #7 screw (included) through the EB-TY Premium fastener into the pilot hole and tighten until snug to the EB-TY Premium fastener.  
When deck boards meet end to end over the top of the joist, only one EB-TY Premium fastener is needed. Slot the deck board ends to accommodate the EB-TY Premium fastener.

## EB-TY® Detailed Installation Instructions

### Installing Additional Deck Boards



**13. Apply adhesive**  
If deck boards are not pregrooved, repeat the process from Step 7, but cutting slots on both edges of the deck board. Apply a bead of exterior construction adhesive to each joist, approximately 10 mm wide.



**14. Align boards**  
Place the board so the slots slip over the exposed EB-TY Premium™ fasteners from the preceding board. Use a rubber mallet, board straightening tool or similar tool to move boards into proper alignment as needed.



**15. Slide in EB-GUIDE**  
Slide the EB-GUIDE into the deck board's grooved side, centring above the joist.



**16. Drill pilot hole**  
Using the drill or impact driver with the 1/8" (3 mm) drill bit (included), insert the drill bit into the EB-GUIDE hole and drill through the edge of the deck board.

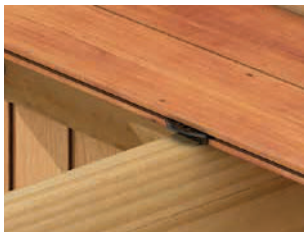

**17. Insert EB-TY**  
Insert one EB-TY Premium fastener into the slot at each joist intersection, aligning EB-TY Premium over the predrilled pilot hole.

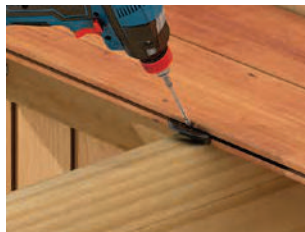

**18. Drive screw**  
Install a #7 screw (included) through the EB-TY Premium fastener into the pilot hole and tighten until snug to the EB-TY Premium fastener. When deck boards meet end to end over the top of the joist, only one EB-TY Premium fastener is needed. Slot the deck board ends to accommodate the EB-TY Premium fastener.

**19. Repeat**  
Repeat the above steps 13–18 for the remainder of the deck except for the last board.

### Installing the Last Board



**20. Setup**  
Cut slots as needed only on the inside edge of the last board to fit over the exposed EB-TY Premium fasteners. Apply a 10 mm-wide bead of exterior construction adhesive to each joist

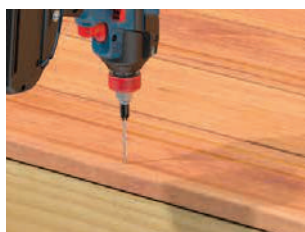

**21. Drill and countersink**  
Place the board so the slots slip over the exposed EB-TY Premium fasteners from the preceding board.

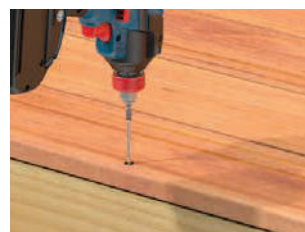

**22. Install screw**  
Repeat Step 2–3, applying fasteners only on the outer edge of the entire deck board.

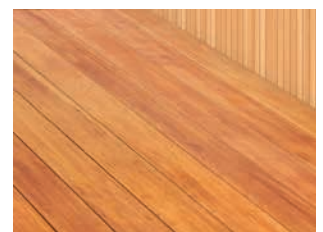

Finished Deck