



ETA-Danmark A/S  
Göteborg Plads 1  
DK-21590 Nordhavn  
Tel. +45 72 24 59 00  
Fax +45 72 24 59 04  
Internet [www.etadanmark.dk](http://www.etadanmark.dk)

Authorised and notified according  
to Article 29 of the Regulation (EU)  
No 305/2011 of the European  
Parliament and of the Council of 9  
March 2011

MEMBER OF EOTA



## European Technical Assessment ETA-23/0255 of 2023/03/28

### I General Part

**Technical Assessment Body issuing the ETA and designated according to Article 29 of the Regulation (EU) No 305/2011: ETA-Danmark A/S**

**Trade name of the construction product:**

AT-HP / AT-HP PLUS / S&P ResAC-19 for post-installed rebar connections

**Product family to which the above construction product belongs:**

Post-installed rebar connections with AT-HP / AT-HP PLUS / S&P ResAC-19 injection mortar

**Manufacturer:**

Simpson Strong-Tie®  
Rue du Camp  
Z.A.C. des Quatre Chemins  
F-85400 Sainte Gemme La Plaine  
Tel. +33 2 51 28 44 00  
Fax +33 2 51 28 44 01  
Internet [www.simpson.fr](http://www.simpson.fr)

**Manufacturing plant:**

Simpson Strong-Tie®  
Manufacturing Facilities

**This European Technical Assessment contains:**

17 pages including 12 annexes which form an integral part of the document

**This European Technical Assessment is issued in accordance with Regulation (EU) No 305/2011, on the basis of:**

EAD 330087-01-0601, Systems for post-installed rebar connections with mortar

**This version replaces:**

Translations of this European Technical Assessment in other languages shall fully correspond to the original issued document and should be identified as such.

Communication of this European Technical Assessment, including transmission by electronic means, shall be in full (except the confidential Annexes referred to above). However, partial reproduction may be made, with the written consent of the issuing Technical Assessment Body. Any partial reproduction has to be identified as such.

## **II SPECIFIC PART OF THE EUROPEAN TECHNICAL ASSESSMENT**

### **1 Technical description of product and intended use**

#### **Technical description of the product**

The subject of this assessment are the post-installed connections, by anchoring or overlap connection joint consisting of steel reinforcing bars (rebars) in existing structures made of normal weight concrete, using injection mortar AT-HP / AT-HP PLUS / S&P ResAC-19 – which are different trade names for the same product – in accordance with the regulations for reinforced concrete construction. The design of the post-installed rebar connections shall be done in accordance with EN 1992-1-1 (Eurocode 2).

Reinforcing bars with diameters from 8 to 12 mm and AT-HP / AT-HP PLUS / S&P ResAC-19 injection mortar are used for the post-installed rebar connections. The steel element is placed into a drilled hole filled with a mortar and is anchored by the bond between embedded element, injection mortar and concrete.

The characteristic material values, dimensions and tolerances of the anchors not indicated in Annexes shall correspond to the respective values laid down in the technical documentation<sup>1</sup> of this European Technical Assessment.

The product description is given in Annex A.

### **2 Specification of the intended use in accordance with the applicable EAD**

The performances given in Section 3 are only valid if the rebar connection is used in compliance with the specifications and conditions given in Annex B

The provisions made in this European Technical Assessment are based on an assumed intended working life of the anchor of 50 years.

The indications given on the working life cannot be interpreted as a guarantee given by the producer or Assessment Body, but are to be regarded only as a means for choosing the right products in relation to the expected economically reasonable working life of the works.

---

<sup>1</sup> The technical documentation of this European Technical Assessment is deposited at ETA-Danmark and, as far as relevant for the tasks of the Notified bodies involved in the attestation of conformity procedure, is handed over to the notified bodies.

### **3 Performance of the product and references to the methods used for its assessment**

#### **3.1 Characteristics of product**

##### **Mechanical resistance and stability (BWR1):**

The essential characteristics are detailed in the Annex C.

##### **Safety in case of fire (BWR2):**

Reaction to fire: Rebar connections satisfy requirements for Class A1.

Resistance to fire: See annex C

##### **Hygiene, health and the environment (BWR3):**

No performance assessed.

##### **Safety in use (BWR4):**

For basic requirement Safety in use the same criteria are valid for Basic Requirement Mechanical resistance and stability (BWR1).

Other Basic Requirements are not relevant.

#### **3.2 Methods of assessment**

The assessment of fitness of the anchor for the intended use in relation to the requirements for mechanical resistance and stability and safety in use in the sense of the Basic Requirements 1 and 4 has been made in accordance with the EAD 330087-01-0601, Systems for post-installed rebar connections with mortar.

## **4 Assessment and verification of constancy of performance (AVCP)**

### **4.1 AVCP system**

According to the decision 96/582/EC of the European Commission, the system(s) of assessment and verification of constancy of performance (see Annex V to Regulation (EU) No 305/2011) is 1.

## **5 Technical details necessary for the implementation of the AVCP system, as foreseen in the applicable EAD**

Technical details necessary for the implementation of the AVCP system are laid down in the control plan deposited at ETA-Danmark prior to CE marking

Issued in Copenhagen on 2023-03-28 by



Thomas Bruun  
Managing Director, ETA-Danmark

### Installation post installed rebar

**Figure A1:** Overlapping joint for rebar connections of slabs and beams

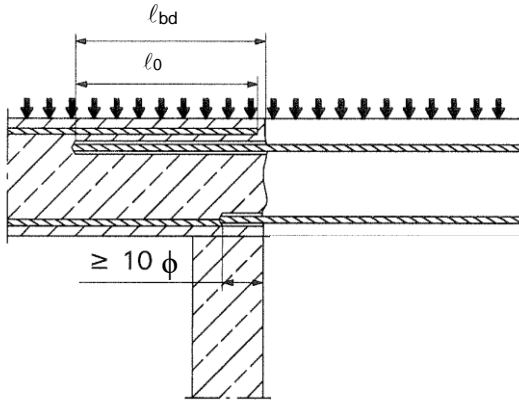

**Figure A3:** End anchoring of slabs or beams (e.g. designed as simply supported)

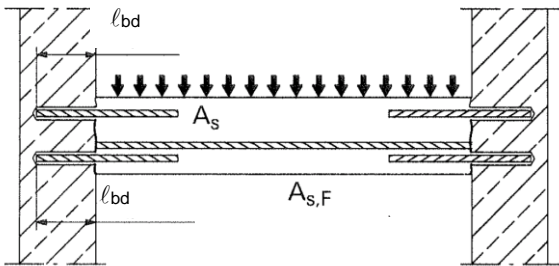

**Figure A5:** Anchoring of reinforcement to cover the line of acting tensile force

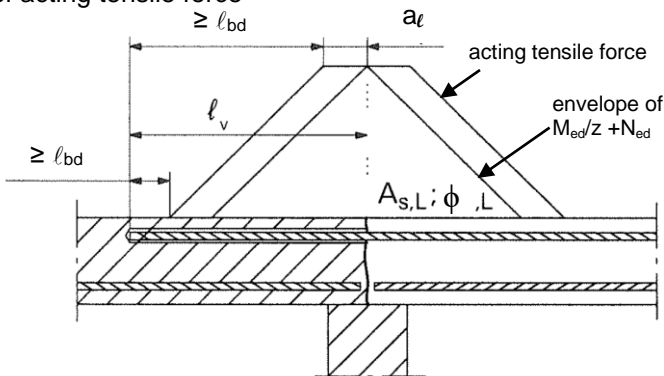

**Figure A2:** Overlapping joint at a foundation of a wall or column where the rebar are stressed in tension

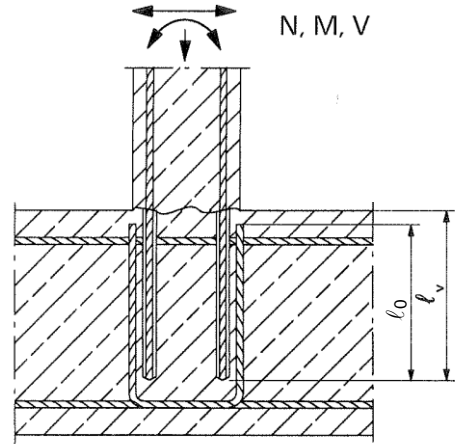

**Figure A4:** Rebar connection for components stressed primarily in compression. The rebar are stressed in compression

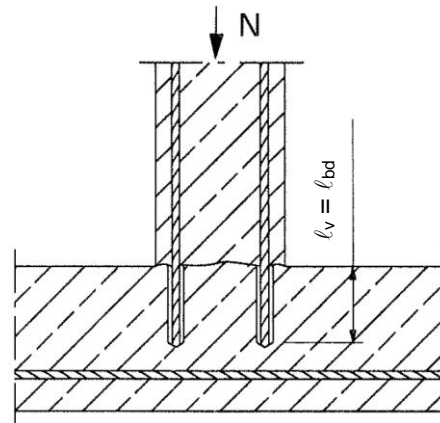

**Note to Figure A1 to A5:**

In the Figures no transverse reinforcement is plotted, the transverse reinforcement shall comply with EN 1992-1-1:2004+AC:2010.

Preparing of joints according to Annex B 2

<p><b>AT-HP / AT-HP PLUS / S&amp;P ResAC-19 Injection System for rebar connection</b></p>	<p><b>Annex A1</b></p>
<p><b>Product description</b> Installed condition and examples of use for rebars</p>	

**AT-HP / AT-HP PLUS / S&P ResAC-19 Injection System**

- A) Foil Bag Cartridge 165ml, 300ml.**
- B) Coaxial Cartridge 380ml / 400 ml / 410 ml / 420ml**
- C) Side by Side Cartridge 345ml, 825ml**

Cartridge Print: AT-HP / AT-HP PLUS / S&P ResAC-19  
 Including - Installation procedure,  
 Production Batch code, Expiry Date,  
 Storage conditions, Health & Safety  
 warning, Gel & Cure time according to  
 temperatures.

**Marking:**  
 AT-HP / AT-HP PLUS / S&P ResAC-19  
 Batch code, either expiry date or  
 manufacturing date with shelf life

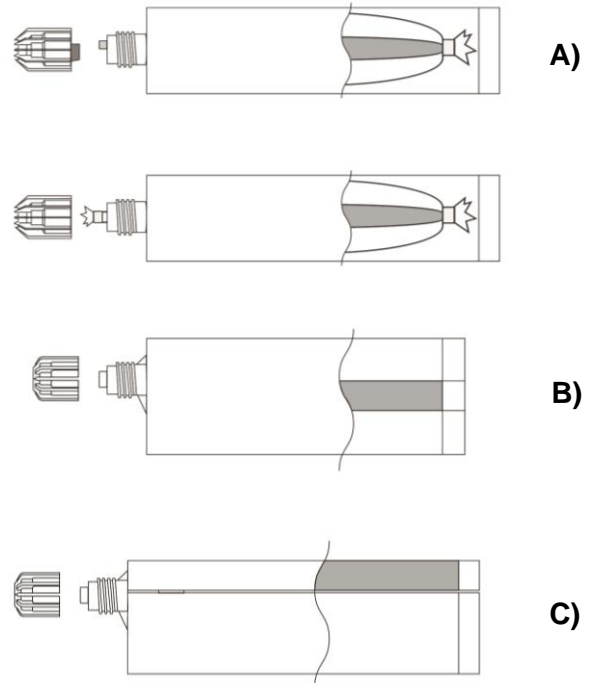

**Mixer with hanger**

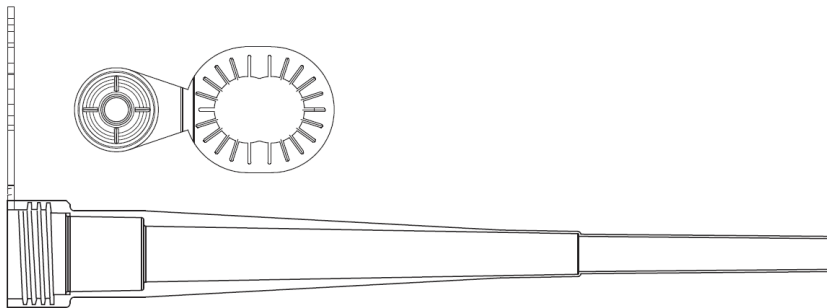

**Mixer**

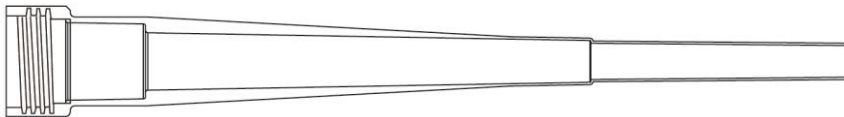

**Mixer Extension**



**AT-HP / AT-HP PLUS / S&P ResAC-19 Injection System for rebar connection**

**Product description**  
 Injection mortar / Static mixer

**Annex A2**

**Reinforcing bar (rebar):  $\varnothing 8$ ,  $\varnothing 10$ ,  $\varnothing 12$ ,**



- Minimum value of related rip area  $f_{R,min}$  according to EN 1992-1-1:2004+AC:2010
- Rib height of the bar shall be in the range  $0,05\phi \leq h \leq 0,07\phi$   
( $\phi$ : Nominal diameter of the bar; h: Rip height of the bar)

**Table A1: Materials**

Designation	Material
Rebar EN 1992-1-1:2004+AC:2010, Annex C	Bars and de-coiled rods class B or C $f_{yk}$ and $k$ according to NDP or NCL of EN 1992-1-1/NA:2013 $f_{uk} = f_{tk} = k \cdot f_{yk}$

**AT-HP / AT-HP PLUS / S&P ResAC-19 Injection System for rebar connection**

**Annex A3**

**Product description**  
Specifications Rebar



## Specifications of intended use

### Anchorage subject to:

- Static and quasi-static loads.
- Fire exposure

### Base materials:

- Reinforced or unreinforced normal weight concrete according to EN 206-1:2000.
- Strength classes C12/15 to C50/60 according to EN 206-1:2000.
- Maximum chloride concrete of 0,40% (CL 0.40) related to the cement content according to EN 206-1:2000.
- Non-carbonated concrete.

Note: In case of a carbonated surface of the existing concrete structure the carbonated layer shall be removed in the area of the post-installed rebar connection with a diameter of  $\phi + 60$  mm prior to the installation of the new rebar.

The depth of concrete to be removed shall correspond to at least the minimum concrete cover in accordance with EN 1992-1-1:2004+AC:2010.

The foregoing may be neglected if building components are new and not carbonated and if building components are in dry conditions.

### Temperature Range:

- - 40°C to +40°C (max. short term temperature +40°C and max long term temperature +23°C).

### Design:

- Anchorages are designed under the responsibility of an engineer experienced in anchorages and concrete work.
- Verifiable calculation notes and drawings are prepared taking account of the forces to be transmitted.
- Design according to EN 1992-1-1:2004+AC: 2010 and Annex B 2.
- The actual position of the reinforcement in the existing structure shall be determined on the basis of the construction documentation and taken into account when designing.
- Anchorages under fire exposure are designed in accordance with EN 1992 – 1- 2:2004+AC:2008

### Installation:

- Dry or wet concrete.
- It must not be installed in flooded holes.
- Hole drilling by hammer drill (HD) or compressed air drill mode (CD).
- The installation of post-installed rebar resp. tension anchors shall be done only by suitable trained installer and under supervision on site; the conditions under which an installer may be considered as suitable trained and the conditions for supervision on site are up to the Member States in which the installation is done.
- Check the position of the existing rebars (if the position of existing rebars is not known, it shall be determined using a rebar detector suitable for this purpose as well as on the basis of the construction documentation and then marked on the building component for the overlap joint).

**AT-HP / AT-HP PLUS / S&P ResAC-19 Injection System for rebar connection**

**Intended use Specifications**

**Annex B1**

**Figure B1: General construction rules for post-installed rebars**

- Only tension forces in the axis of the rebar may be transmitted
- The transfer of shear forces between new concrete and existing structure shall be designed additionally according to EN 1992-1-1:2004+AC: 2010.
- The joints for concreting must be roughened to at least such an extent that aggregate protrude.

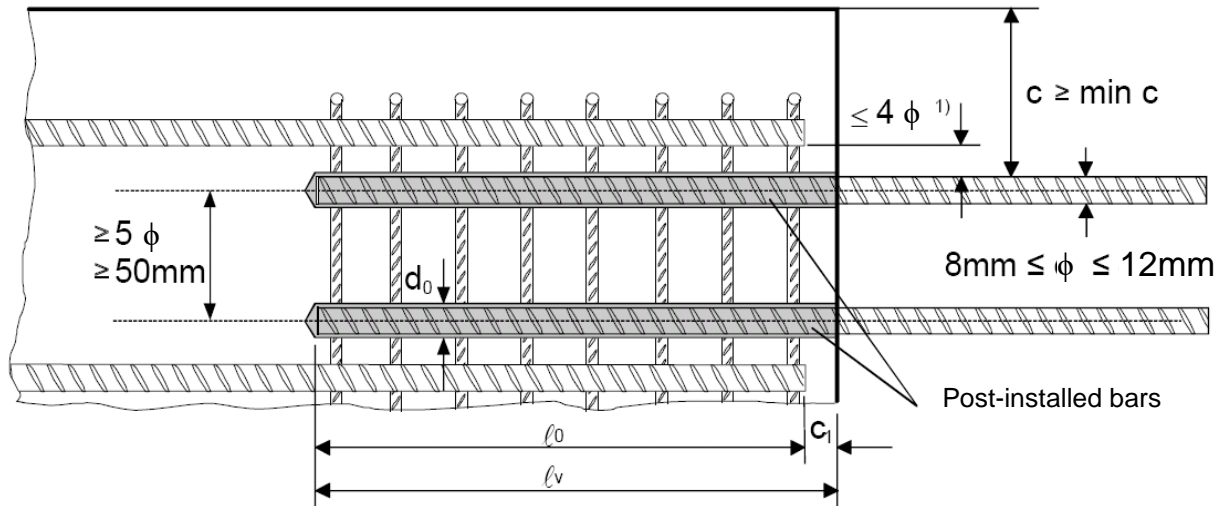

- 1) If the clear distance between lapped bars exceeds  $4\phi$ , then the lap length shall be increased by the difference between the clear bar distance and  $4\phi$ .

The following applies to Figure B1:

$c$	concrete cover of post-installed rebar
$c_1$	concrete cover at end-face of existing rebar
$\min c$	minimum concrete cover according to Table B1 and to EN 1992-1-1:2004+AC:2010, Section 4.4.1.2
$\phi$	diameter of post-installed rebar
$l_0$	lap length, according to EN 1992-1-1:2004+AC: 2010, Section 8.7.3
$l_v$	effective embedment depth, $\geq l_0 + c_1$
$d_0$	nominal drill bit diameter, see Annex B5

**AT-HP / AT-HP PLUS / S&P ResAC-19 Injection System for rebar connection**

**Intended use**

General construction rules for post-installed rebars

**Annex B2**

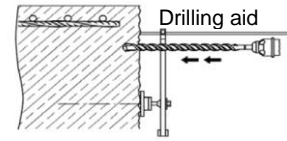
**Table B1: Minimum concrete cover  $\min c^{1)}$  of post-installed rebar depending of drilling method**

Drilling method	Rebar diameter	Without drilling aid	With drilling aid
Hammer drilling (HD)	$\leq 12 \text{ mm}$	$30 \text{ mm} + 0,06 \cdot l_v \geq 2 \phi$	$30 \text{ mm} + 0,02 \cdot l_v \geq 2 \phi$
Compressed air drilling (CD)	$\leq 12 \text{ mm}$	$50 \text{ mm} + 0,08 \cdot l_v$	$50 \text{ mm} + 0,02 \cdot l_v$

1) see Annex B2 & Figures B1

Comments: The minimum concrete cover acc. EN 1992-1-1:2004+AC:2010 must be observed

**Table B2: maximum embedment depth  $l_{v,max}$** 

Rebar	$l_{v,max} \text{ [mm]}$
$\phi$	
8 mm	750
10 mm	750
12 mm	750

**Table B3: Base material temperature, gelling time and curing time**

Minimum base material temperature [C°]	Gel time <sup>1)</sup> (working time) In dry/wet concrete	Curing time in dry concrete	Curing time in wet concrete
$0^\circ\text{C} \leq T_{\text{base material}} < 10^\circ\text{C}$	20 min	90 min	12 h
$10^\circ\text{C} \leq T_{\text{base material}} < 20^\circ\text{C}$	9 min	60 min	8 h
$20^\circ\text{C} \leq T_{\text{base material}} < 30^\circ\text{C}$	5 min	30 min	4 h
$30^\circ\text{C} \leq T_{\text{base material}} \leq 40^\circ\text{C}$	3 min	20 min	3 h

1)  $t_{\text{gel}}$ : maximum time from starting of mortar injection to completing of rebar setting.

2) Cartridge temperature **must** be at minimum  $+20^\circ\text{C}$

**AT-HP / AT-HP PLUS / S&P ResAC-19 Injection System for rebar connection**





**Intended use**

Minimum concrete cover

Maximum embedment depth / working time and curing times

**Annex B3**

**Table B4: Dispensing tools**

<b>Resin injection pump details</b>		
<b>Image</b>	<b>Size Cartridge / Code</b>	<b>Type</b>
	165 / 300ml 165 / 300 ml 10:1	Manual
	345 / 380 / 400 / 410 / 420ml 420 ml 10:1 345 ml 10:1	Manual
	165 / 300 / 345 / 380 / 400 / 410 / 420ml 165 / 300 ml 345ml 380 / 400 / 410 / 420 ml 7.4v Tool	Battery
	380 / 400 / 410 / 420 / 825ml 380 / 400 / 410 / 420 ml 825ml	Pneumatic

**AT-HP / AT-HP PLUS / S&P ResAC-19 Injection System for rebar connection**

**Intended Use**  
Dispensing tools

**Annex B4**

### A) Bore hole drilling

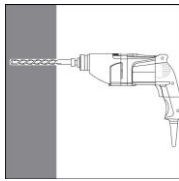

1 Drill a hole into the base material to the size and embedment depth required by the selected reinforcing bar with carbide hammer drill (HD) or a compressed air drill (CD). In case of aborted drill hole: the drill hole shall be filled with mortar.

Rebar - $\phi$	Drill - $\varnothing$ [mm]
8 mm	12 or 14
10 mm	12 or 14
12 mm	14 or 16



Hammer drill (HD)

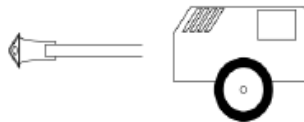

Compressed air drill (CD)

### B) Bore hole cleaning (HD and CD)

**MAC: Cleaning for bore hole diameter  $d_0 \leq 16\text{mm}$  and bore hole depth  $h_0 \leq 10d_s$  for dry concrete only**

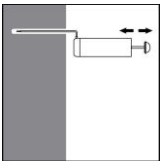

2a. Starting from the bottom or back of the bore hole, blow the hole clean a hand pump (Annex B6) a minimum of 4 times.

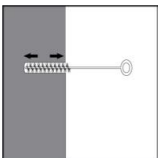

2b. Check brush diameter (Table B5). Brush the hole with an appropriate sized wire brush  $> d_{b,\text{min}}$  (Table B5) a minimum of 4 times in a twisting motion. If the bore hole ground is not reached with the brush, a brush extension shall be used.

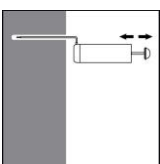

2c. Blow starting from the bottom or back of the bore hole a minimum of 4 times, until return air stream is free from noticeable dust

**AT-HP / AT-HP PLUS / S&P ResAC-19 Injection System for rebar connection**

**Intended Use**

Installation instruction: Bore hole drilling and Bore hole cleaning

**Annex B5**

**CAC: Cleaning for all bore hole diameter and bore hole depth for dry and wet concrete**

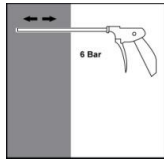

**2a.** Starting from the bottom or back of the bore hole, blow the hole clean with compressed air (min. 6 bar) (Annex B6) a minimum of 4 times until return air stream is free of noticeable dust. If the bore hole ground is not reached an extension shall be used.

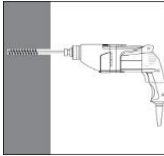

**2b.** Check brush diameter (Table B5). Brush the hole with an appropriate sized wire brush  $> d_{b,min}$  (Table B5) a minimum of 4 times. If the bore hole ground is not reached with the brush, a brush extension shall be used (Table B5). **For wet concrete**, the brush will be always sated in a drilling machine.

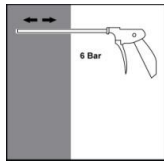

**2c.** Finally blow the hole clean again with compressed air (min. 6 bar) (Annex B6) a minimum of 4 times until return air stream is free of noticeable dust. If the bore hole ground is not reached an extension shall be used.

**Table B5: Cleaning tools**

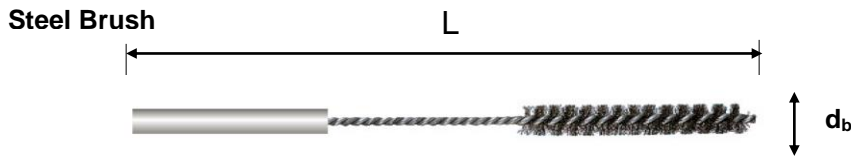

Brush extension:



$\phi$ Rebar (mm)	$d_0$ Drill bit - $\phi$ (mm)	$d_b$ Brush - $\phi$ (mm)	Manual cleaning (for dry conditions only)	Compressed air cleaning
8	12 or 14	12 or 14	YES ( $h_{ef} \leq 80\text{mm}$ )	YES
10	12 or 14	12 or 14	YES ( $h_{ef} \leq 100\text{mm}$ )	YES
12	14 or 16	14 or 16	YES ( $h_{ef} \leq 120\text{mm}$ )	YES



**Compressed air tool  
hand slide valve (min 6 bar)**



**Push Pump**

**AT-HP / AT-HP PLUS / S&P ResAC-19 Injection System for rebar connection**

**Intended Use**  
Installation instruction: Bore hole cleaning  
Cleaning tools and

**Annex B6**

**C) Preparation of bar and cartridge**

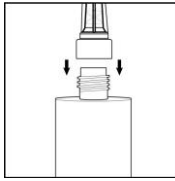

- 3.** Attach the supplied static-mixing nozzle to the cartridge and load the cartridge into the correct dispensing tool.  
For every working interruption longer than the recommended working time (Table B3) as well as for every new cartridges, a new static-mixer shall be used.

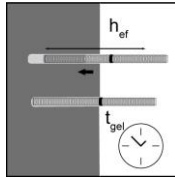

- 4.** Prior to inserting the reinforcing bar into the filled bore hole, the position of the embedment depth shall be marked (e.g. with tape) on the reinforcing bar and insert bar in empty hole to verify hole and depth  $l_v$ .  
The reinforcing bar should be free of dirt, grease, oil or other foreign material.

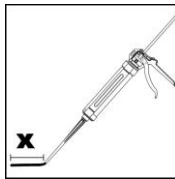

- 5.** Prior to dispensing into the anchor hole, squeeze out separately the mortar until it shows a consistent grey colour, but a minimum of three full strokes, and discard non-uniformly mixed adhesive components.

**D) Filling the bore hole**

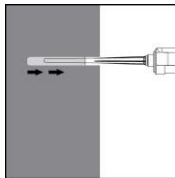

- 6.** Starting from the bottom or back of the cleaned anchor hole fill the hole up to approximately two-thirds with adhesive. Slowly withdraw the static mixing nozzle as the hole fills to avoid creating air pockets.

Observe the gel-/ working times given in Table B3.

**E) Inserting the rebar**

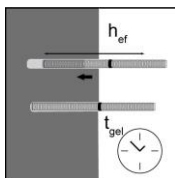

- 7.** Push the reinforcing bar into the anchor hole while turning slightly to ensure positive distribution of the adhesive until the embedment depth is reached.

The bar should be free of dirt, grease, oil or other foreign material.

- 8.** Be sure that the bar is inserted in the bore hole until the embedment mark is at the concrete surface and that excess mortar is visible at the top of the hole. If these requirements are not maintained, the application has to be renewed. For overhead installation fix embedded part (e.g. wedges).

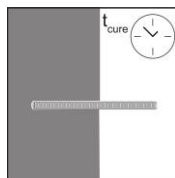

- 9.** Observe gelling time  $t_{gel}$ . Attend that the gelling time can vary according to the base material temperature (see Table B3). It is not allowed to move the bar after gelling time  $t_{gel}$  has elapsed.  
Allow the adhesive to cure to the specified time prior to applying any load. Do not move or load the bar until it is fully cured (attend Table B3). After full curing time  $t_{cure}$  has elapsed, the add-on part can be installed.

**AT-HP / AT-HP PLUS / S&P ResAC-19 Injection System for rebar connection**

**Intended Use**  
Installation instruction: Preparation of bar and cartridge  
Filling the bore hole, Inserting rebar

**Annex B7**

### Minimum anchorage length and minimum lap length

The minimum anchorage length  $\ell_{b,min}$  and the minimum lap length  $\ell_{0,min}$  according to EN 1992-1-1:2004+AC:2010 ( $\ell_{b,min}$  acc. to Eq. 8.6 and Eq. 8.7 and  $\ell_{0,min}$  acc. to Eq. 8.11) shall be multiplied by the amplification factor  $\alpha_{lb}$  according to Table C1.

The design bond strength  $f_{bd}$  according to EN 1992-1-1:2004+AC:2010 (Eq.8.3) shall be multiplied by the factor  $k_b$  according to Table C2 to determine the design values of the ultimate bond stress for post installed rebars  $f_{bd,PIR}$ , which are given in Table C3.

**Table C1: Amplification factor  $\alpha_{lb}$  related to concrete class and drilling method**

Concrete class	Drilling method	Rebar size	Amplification factor $\alpha_{lb}$
C12/15 to C50/60	Hammer drilling (HD) and compressed air drilling (CD)	8 mm to 12 mm	1,5

**Table C2: Bond efficiency factor  $k_b$**

Rebar - $\emptyset$	Concrete class								
	C12/15	C16/20	C20/25	C25/30	C30/37	C35/45	C40/50	C45/55	C50/60
8 mm	1,0	1,0	1,0	0,85	0,77	0,68	0,62	0,58	0,53
10 mm							0,73	0,68	0,63
12 mm									

**Table C3: Design values of the ultimate bond stress  $f_{bd,PIR}$  in N/mm<sup>2</sup> for all drilling methods for good conditions**

according to EN 1992-1-1:2004+AC:2010 for good bond conditions  
(for all other bond conditions multiply the values by 0.7)

Rebar - $\emptyset$	Concrete class								
	C12/15	C16/20	C20/25	C25/30	C30/37	C35/45	C40/50	C45/55	C50/60
8 mm	1,6	2,0	2,3	2,3	2,3	2,3	2,3	2,3	2,3
10 mm							2,7	2,7	2,7
12 mm									

**AT-HP / AT-HP PLUS / S&P ResAC-19 Injection System for rebar connection**

**Performances**

Amplification factor  $\alpha_{lb}$ , reduction factor  $K_b$   
Design values of ultimate bond resistance  $f_{bd}$

**Annex C1**



**Design value of the ultimate bond stress  $f_{bd,fi}$  under fire exposure for concrete classes C12/15 to C50/60, (all drilling methods):**

The design value of the bond strength  $f_{bd,fi}$  under fire exposure has to be calculated by the following equation:

$$f_{bd,fi} = k_{fi}(\theta) \cdot f_{bd,PIR} \cdot \gamma_c / \gamma_{M,fi}$$

$f_{bd,fi}$  Design value of the ultimate bond stress in case of fire in N/mm<sup>2</sup>

$$k_{fi}(\theta) = \frac{16.76 \cdot e^{-0.014 \cdot \theta}}{f_{bd,PIR} \cdot 4.3} \leq 1,0 \quad \theta \leq 181^\circ\text{C}$$

$$k_{fi}(\theta) = 0 \quad \theta > 181^\circ\text{C}$$

$\theta$  Temperature in °C in the mortar layer .

$k_{fi}(\theta)$  Reduction factor under fire exposure.

$f_{bd,PIR}$  Design value of the ultimate bond stress in N/mm<sup>2</sup> in cold condition according to Table C3 considering the concrete classes, the rebar diameter, the drilling method and the bond conditions according to EN 1992-1-1.

$\gamma_c$  partially safety factor according to EN 1992-1-1

$\gamma_{M,fi}$  partially safety factor according to EN 1992-1-2

For evidence under fire exposure the anchorage length shall be calculated according to EN 1992-1-1:2004+AC:2010 Equation 8.3 using the temperature-dependent ultimate bond stress  $f_{bd,fi}$ .

**Example graph of Reduction factor  $k_{fi}(\theta)$  for concrete classes C20/25 for good bond conditions:**

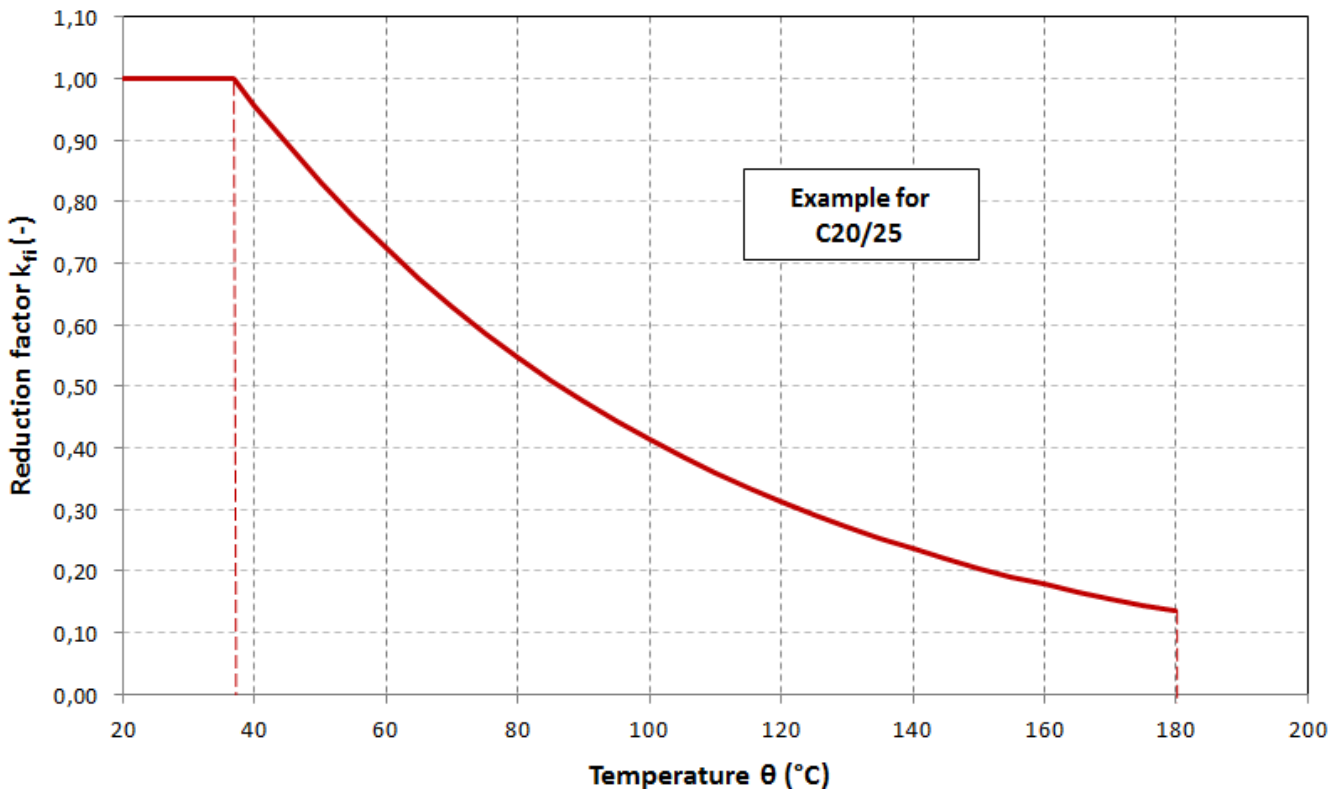

AT-HP / AT-HP PLUS / S&P ResAC-19 Injection System for rebar connection

Performances  
Design value of bond strength  $f_{bd,fi}$  under fire exposure

Annex C2